

3031109RR(OAK/WHITE) RH RAKEL BOOKCASE

Weight Limit
20 lbs / 9.1 KG (per shelf)

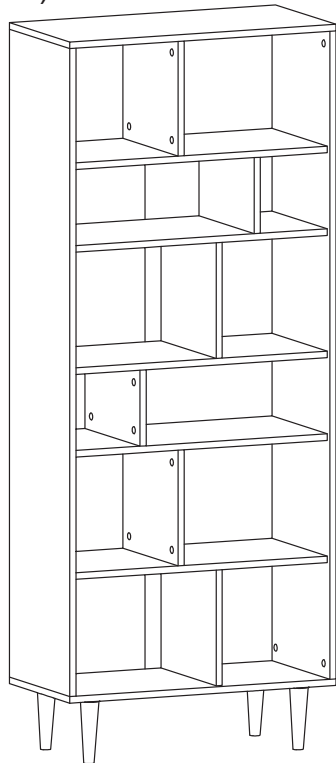

Thank you for purchasing from RealRooms!

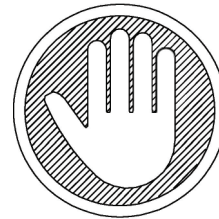

**Questions, concerns, missing parts?
CONTACT OUR CUSTOMER SERVICE DEPARTMENT
BEFORE RETURNING PRODUCT TO THE RETAILER.**

If parts are missing or damaged, we will gladly ship your replacement parts free of charge.

Visit www.realrooms.com
or call Toll-Free **1-888-489-0077**

Date of Purchase

Lot Number (TAKEN FROM CARTON)



**THIS INSTRUCTION BOOKLET CONTAINS IMPORTANT SAFETY
INFORMATION. PLEASE READ AND KEEP FOR FUTURE REFERENCE.**

Limited 1 year Warranty

RealRooms warrants this product to be free from defects in material and workmanship and agrees to remedy any such defect. This warranty covers one year from the date of original purchase from authorized retailers. This is solely limited to the repair or replacement of defective parts and assembly labor is not included.

This warranty does not apply to any product which has been improperly assembled, subjected to misuse or abuse or which has been altered or repaired in any way. The warranty does not cover wearing, tearing, fading or splitting of the fabric (where applicable). Liability for consequential damages is excluded to the extent exclusion is permitted by law. This warranty gives you specific legal rights and you may also have other rights which vary from state to state or province to province.

To obtain warranty service, purchaser must present original bill of sale. Components repaired or replaced are warranted through the remainder of the original warranty period only. The defective components will be repaired or replaced without charge, subject to the terms and conditions described above.

The terms and conditions of the limited warranty are subject to change without notice.

Contact Us!

For help with assembly, identifying parts, product information or to order parts, please contact us:



cs@realrooms.com



1-888-489-0077

Read Before Beginning Assembly

- Work in a spacious area and near where the unit will be used, preferably on a carpet, or use a piece of the cardboard packaging to protect your floor and product.
- Make sure all parts are included. Most parts are labeled or stamped on the raw edge.
- Read each step carefully. It is very important that each step of the instructions is performed in the correct order. If these steps are not followed in sequence, assembly difficulties will occur.
- This product may contain small components. Please ensure that they are kept away from small children.
- This product is designed for home use and is not intended for commercial use.

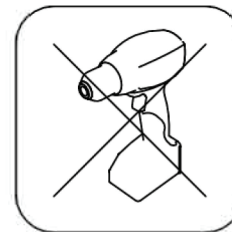
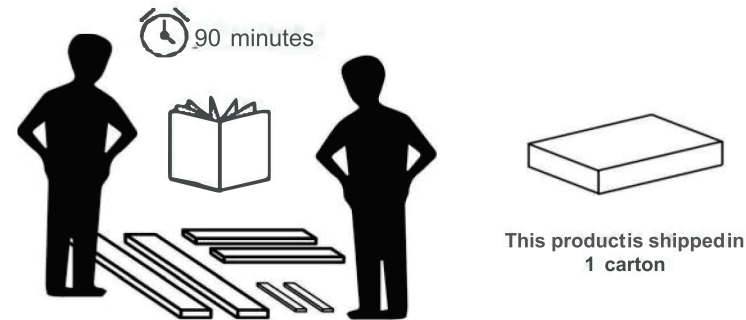

Do NOT use
power tools

Tools required to complete assembly (not included)



Phillips head screwdriver



Mallet



Hammer

PARTS

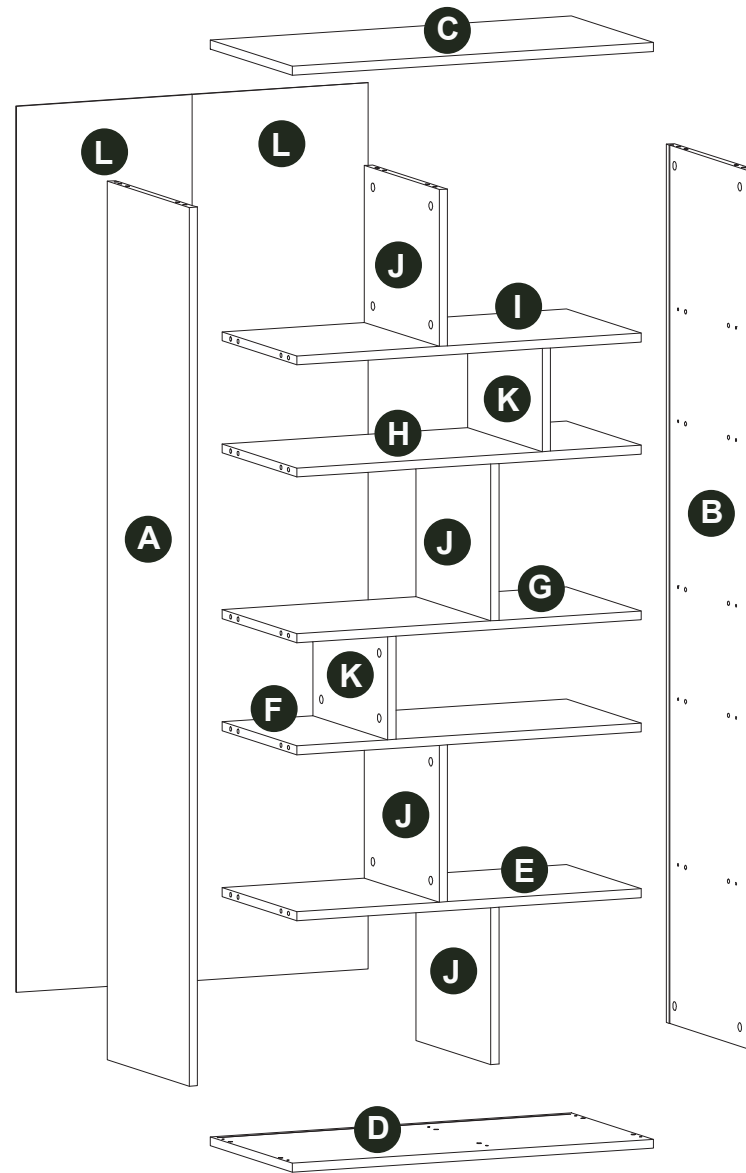

PARTS LIST

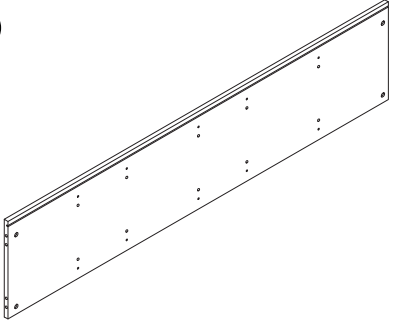
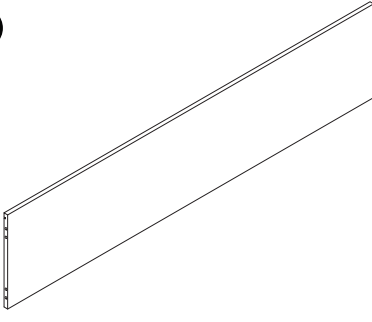
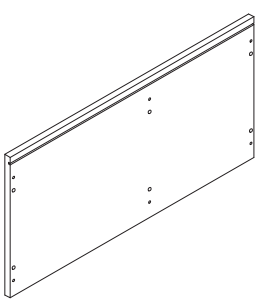
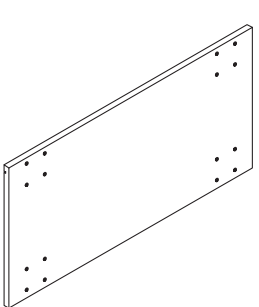
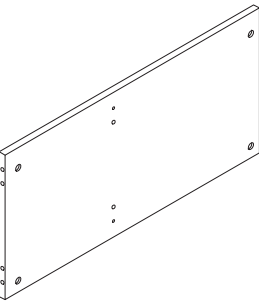
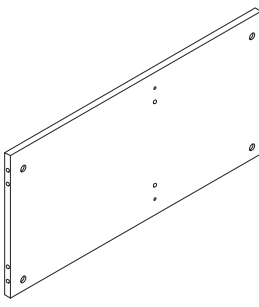
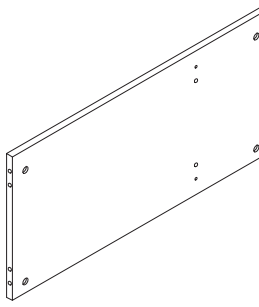
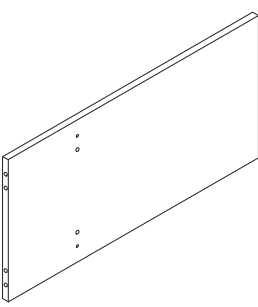
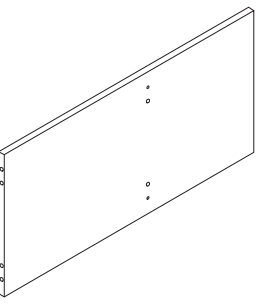
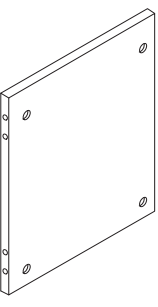
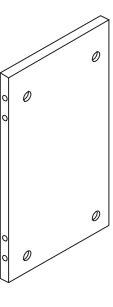
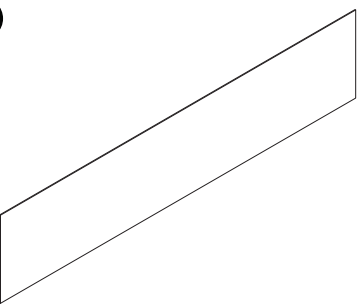

			
<p>SIDE PANEL LEFT 1PC</p>	<p>SIDE PANEL RIGHT 1PC</p>	<p>TOP PANEL 1PC</p>	<p>BOTTOM PANEL 1PC</p>
			
<p>SHELF PANEL 1 1PC</p>	<p>SHELF PANEL 2 1PC</p>	<p>SHELF PANEL 3 1PC</p>	<p>SHELF PANEL 4 1PC</p>
			
<p>SHELF PANEL 5 1PC</p>	<p>MIDDLE PANEL 1 4PCS</p>	<p>MIDDLE PANEL 2 2PCS</p>	<p>BACK PANEL 2PCS</p>

PART NUMBERS	
PART LABELS	3031109RR (Oak/White)
A	U1770852-A
B	U1770852-B
C	U1770852-C
D	U1770852-D
E	U1770852-E
F	U1770852-F
G	U1770852-G
H	U1770852-H
I	U1770852-I
J	U1770852-J
K	U1770852-K
L	U1770852-L

 Each part has a unique part number. Please reference the appropriate part number when contacting customer service for replacement parts.

 Before throwing any packaging, please verify all contents and make sure you have received all the parts listed above!

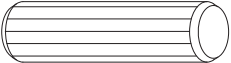
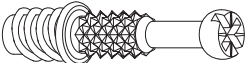
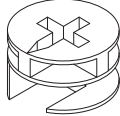
HARDWARE LIST

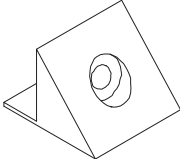
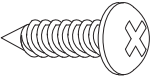
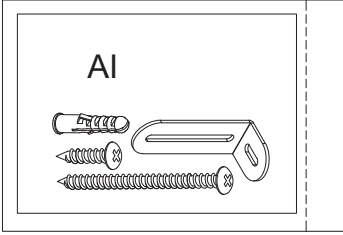
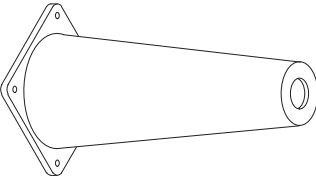
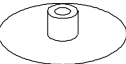
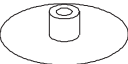
8	2	3	9	10
				
8mm x 30mm WOOD DOWEL 52PCS	24mm x 5mm MINIFIX 52PCS	15mm x 12mm CAM 52PCS	16mm x 3.5mm SCREW 12PCS	14mm x 13mm CORNER BLOCK 12PCS
11	7	12	13	14
				
12mm x 10mm SCREW 16PCS	ANTI TIPPING SET 1SET	150mm x 65mm ROUND LEG 4PCS	18mm x 6mm SCREW CAP(WHITE) 44PCS	18mm x 6mm SCREW CAP(OAK) 8PCS

Hardware Pack

3031109RR (Oak/White)

■ □ HP #: TU1770852-01

 Please do not completely tighten all the hardware, until the entire assembly is complete, unless otherwise indicated in the step-by-step instructions.

 The screw(s), bolt(s) to be used at each step are shown in actual size in the lower right corner of the page.

Step 1

Insert the dowel (8) on panels as shown.

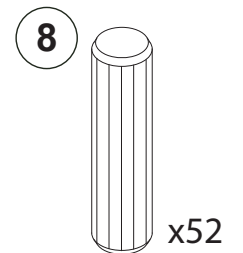
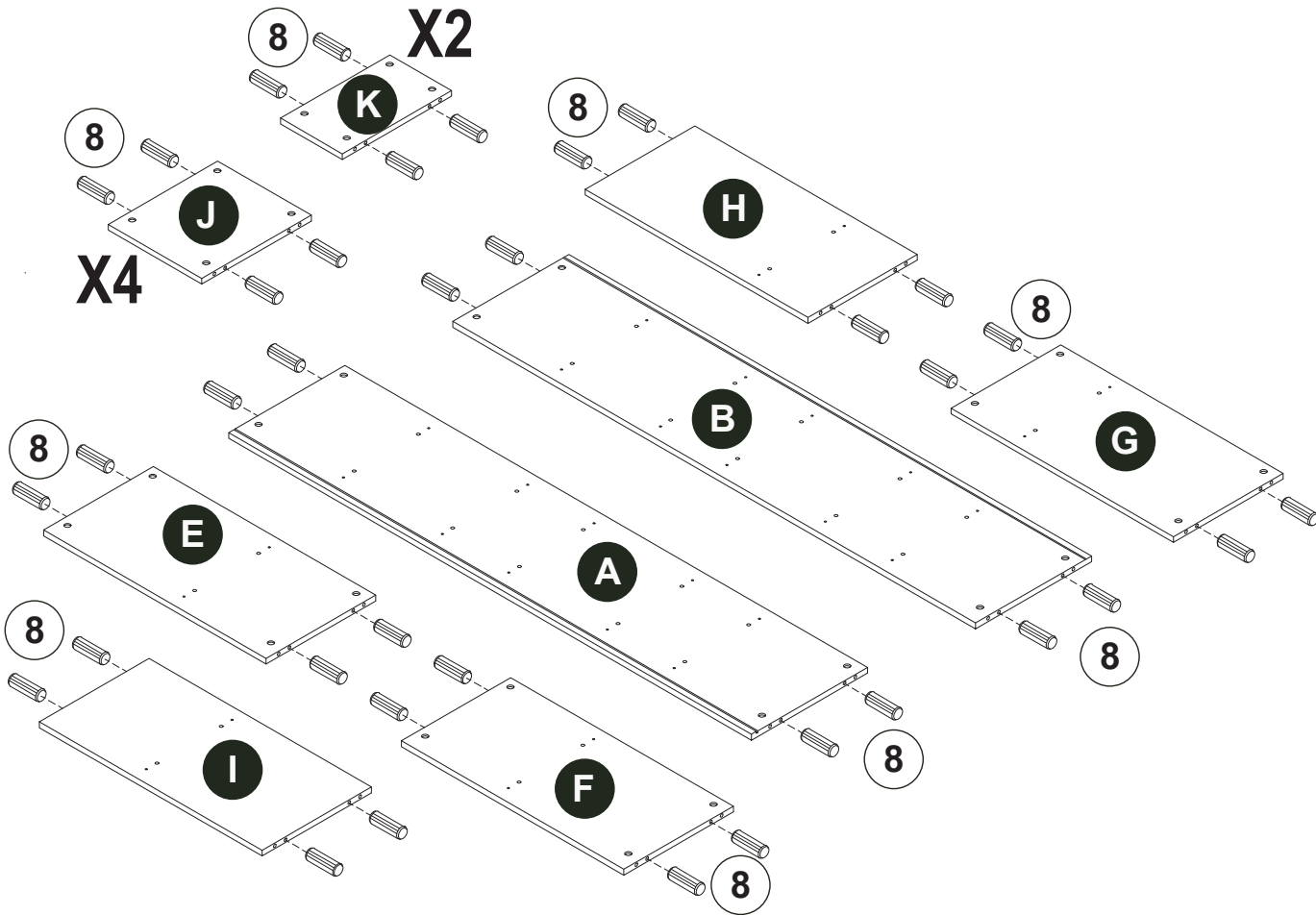
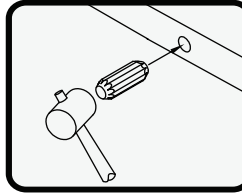

Step 2



Phillips head screwdriver

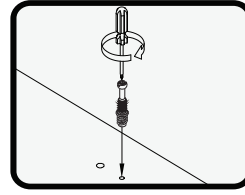

Insert the minifix (2) to the panels as shown, tighten with screwdriver.

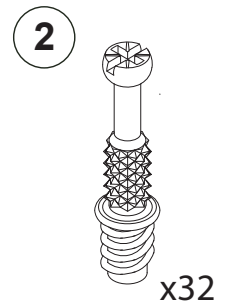
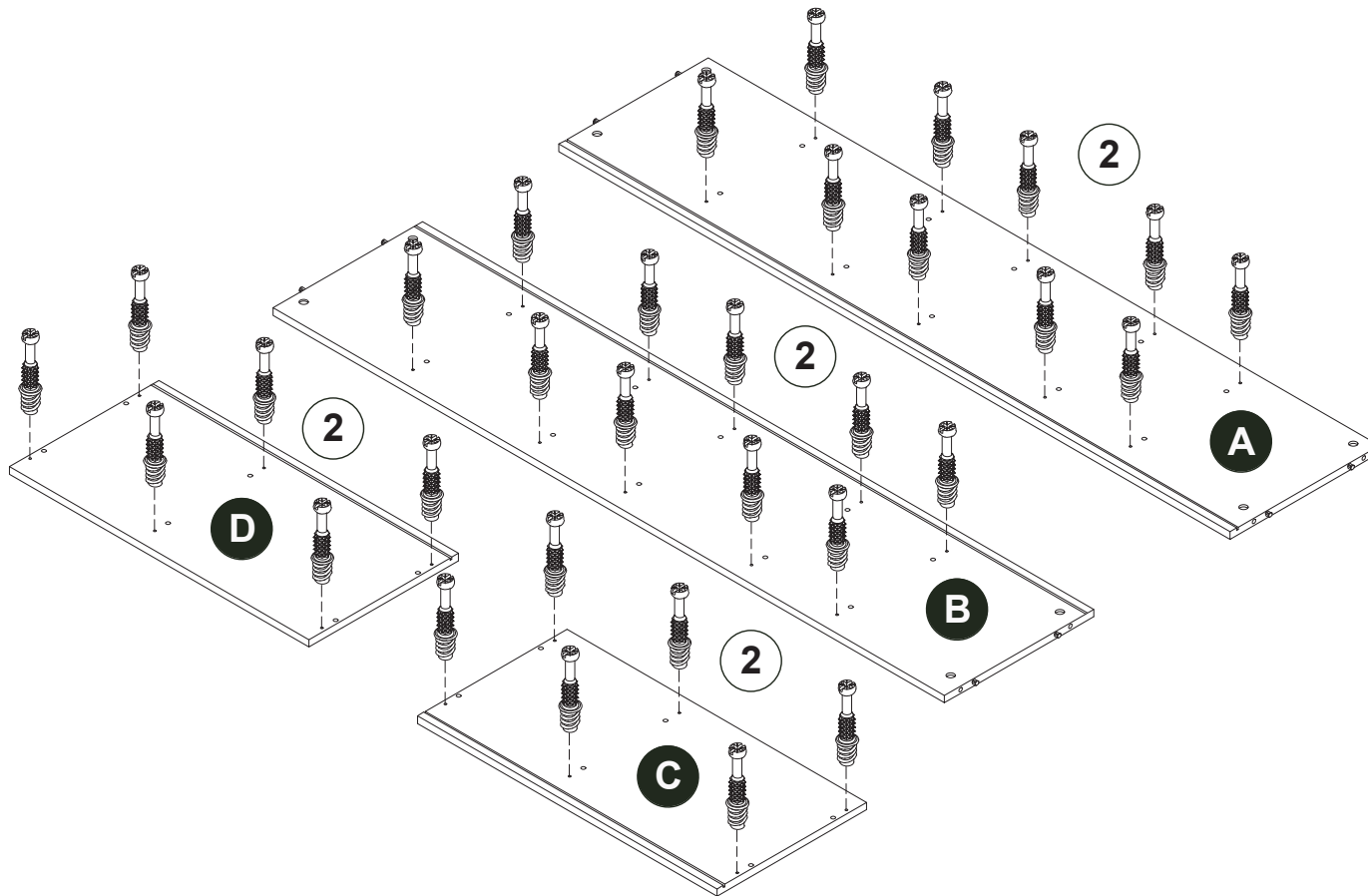

Step 3

Insert the minifix (2) to the panels as shown, tighten with screwdriver.



Phillips head screwdriver

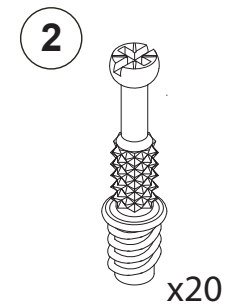
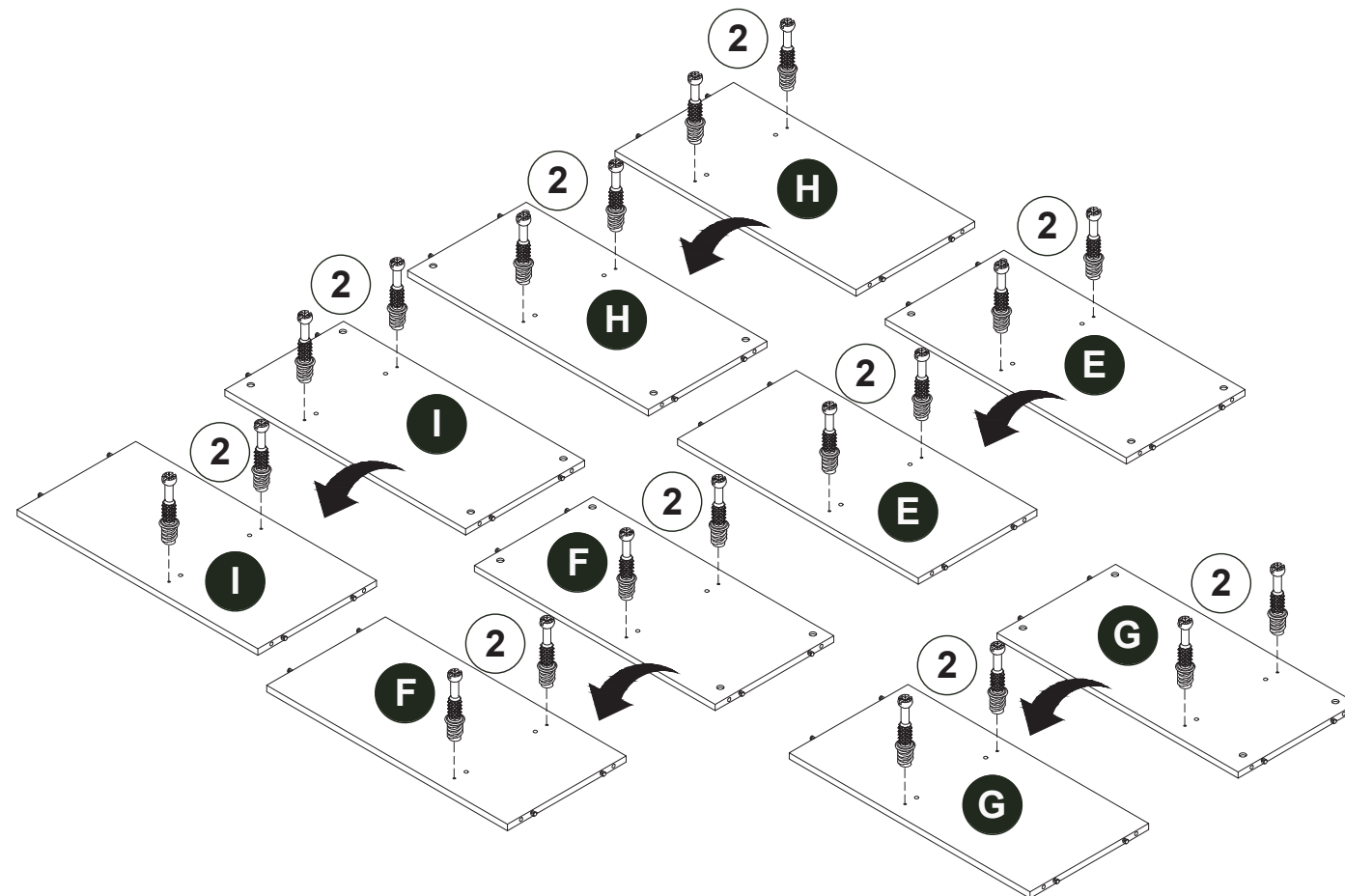
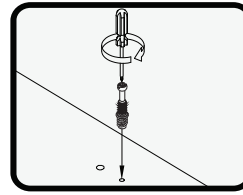



Phillips head screwdriver

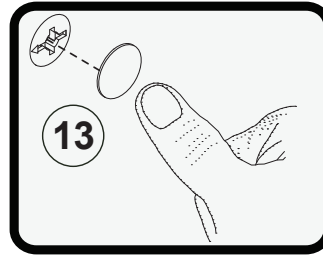
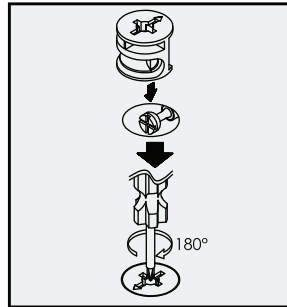

Step 4

Insert cam (3) to panel (J) as shown, then attach panel (J) to panel (E), tighten all the cam (3) with screwdriver.

Insert screw cap (13) on cam (3) as shown.

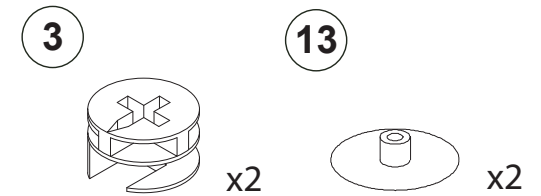
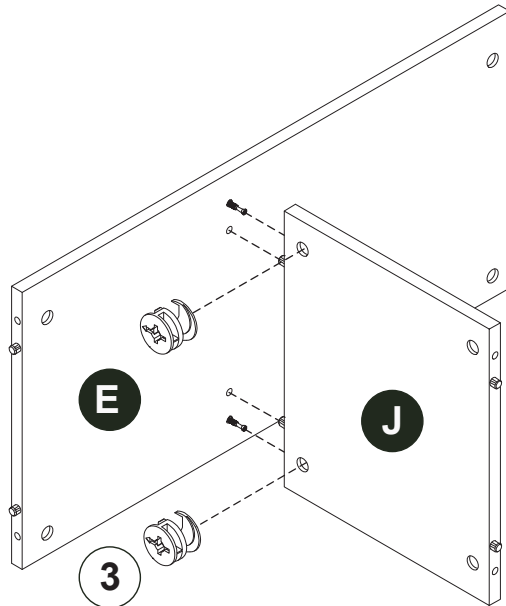



Phillips head screwdriver

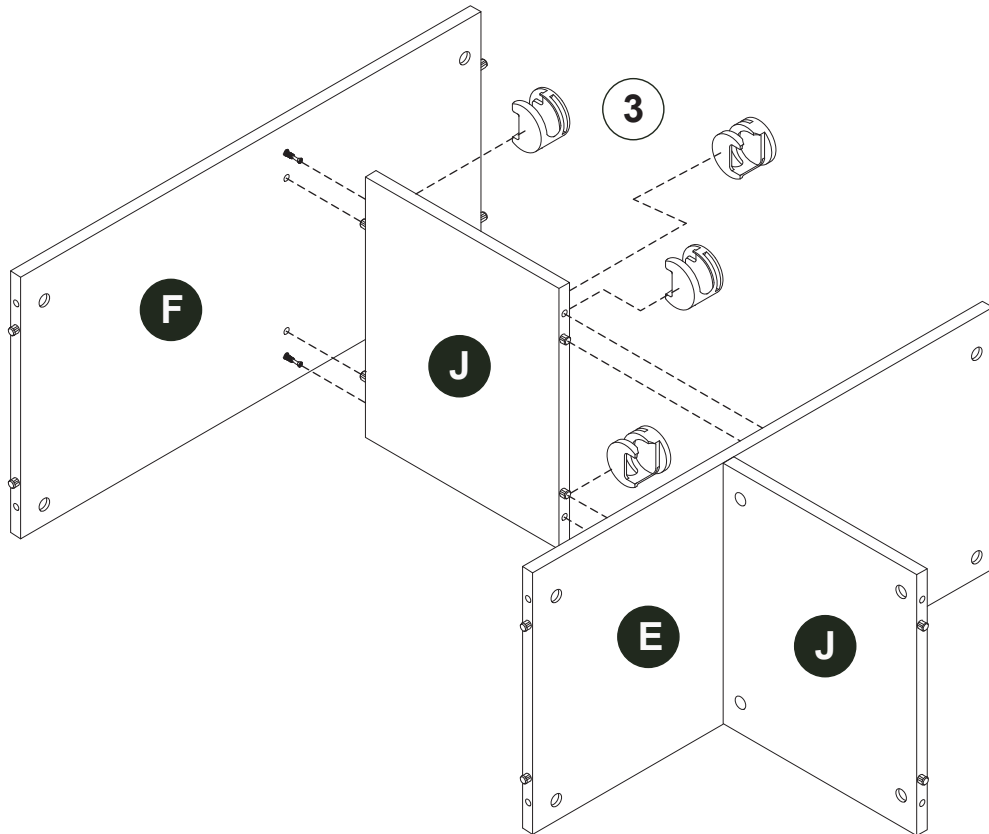
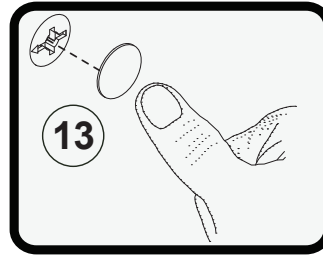
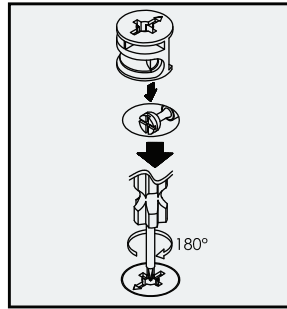

Step 5

Insert cam (3) to panel (J) as shown, then attach panel (J) to panel (E) and (F), tighten all the cam (3) with screwdriver.

Insert screw cap (13) on cam (3) as shown.

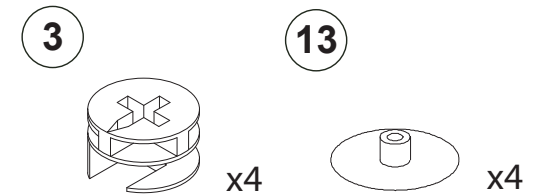

Step 6

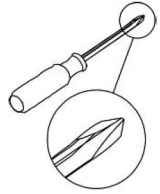

Phillips head screwdriver

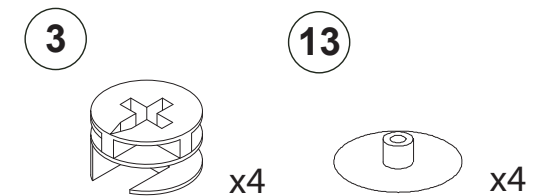
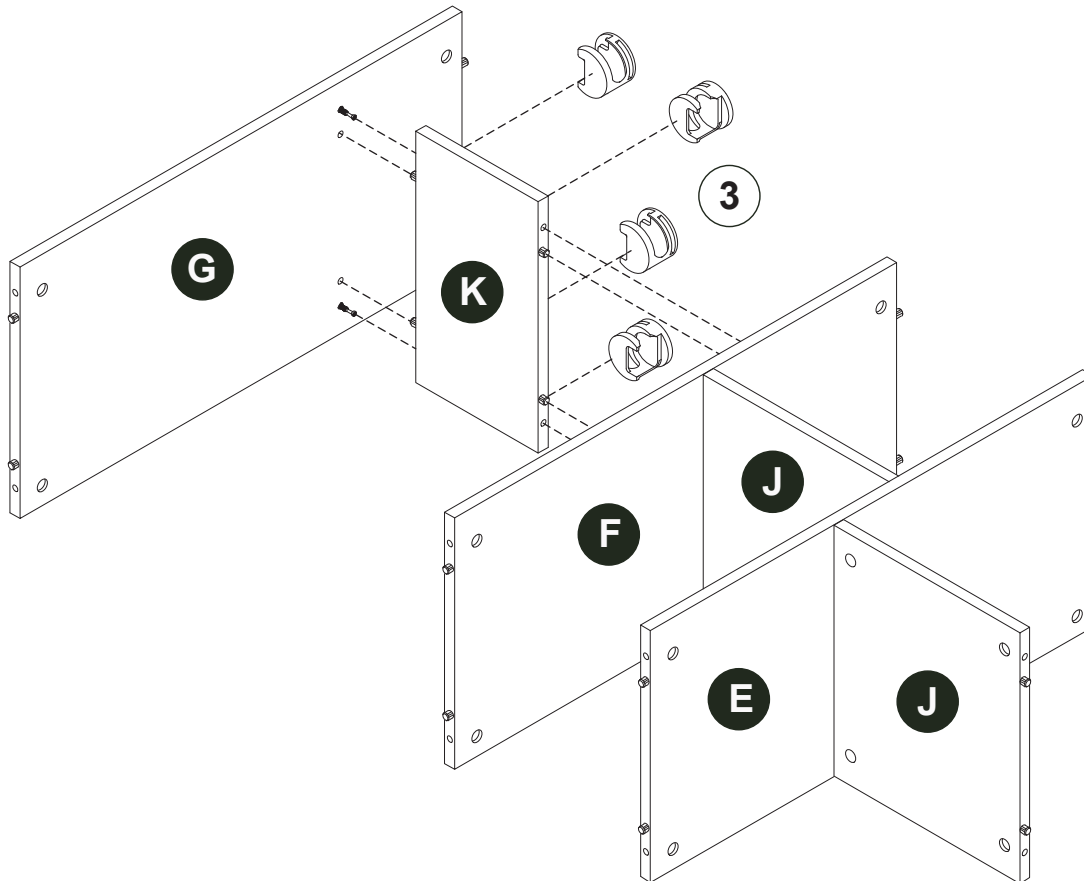
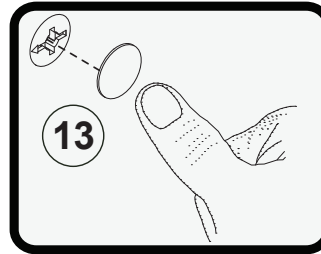
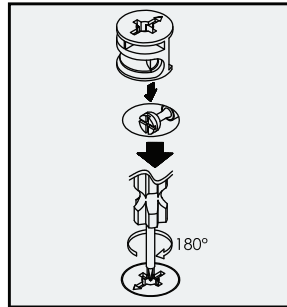

Insert cam (3) to panel (K) as shown, then attach panel (K) to panel (F) and (G), tighten all the cam (3) with screwdriver.

Insert screw cap (13) on cam (3) as shown.

Step 7

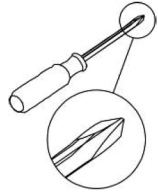

Phillips head screwdriver

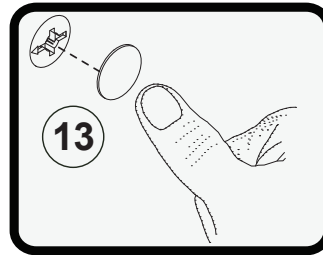
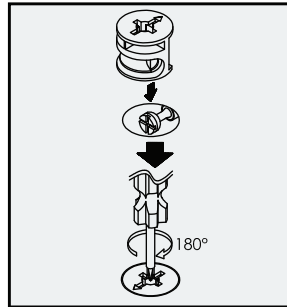

Insert cam (3) to panel (J) as shown, then attach panel (J) to panel (G) and (H), tighten all the cam (3) with screwdriver.

Insert screw cap (13) on cam (3) as shown.

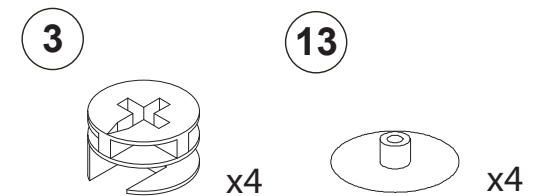
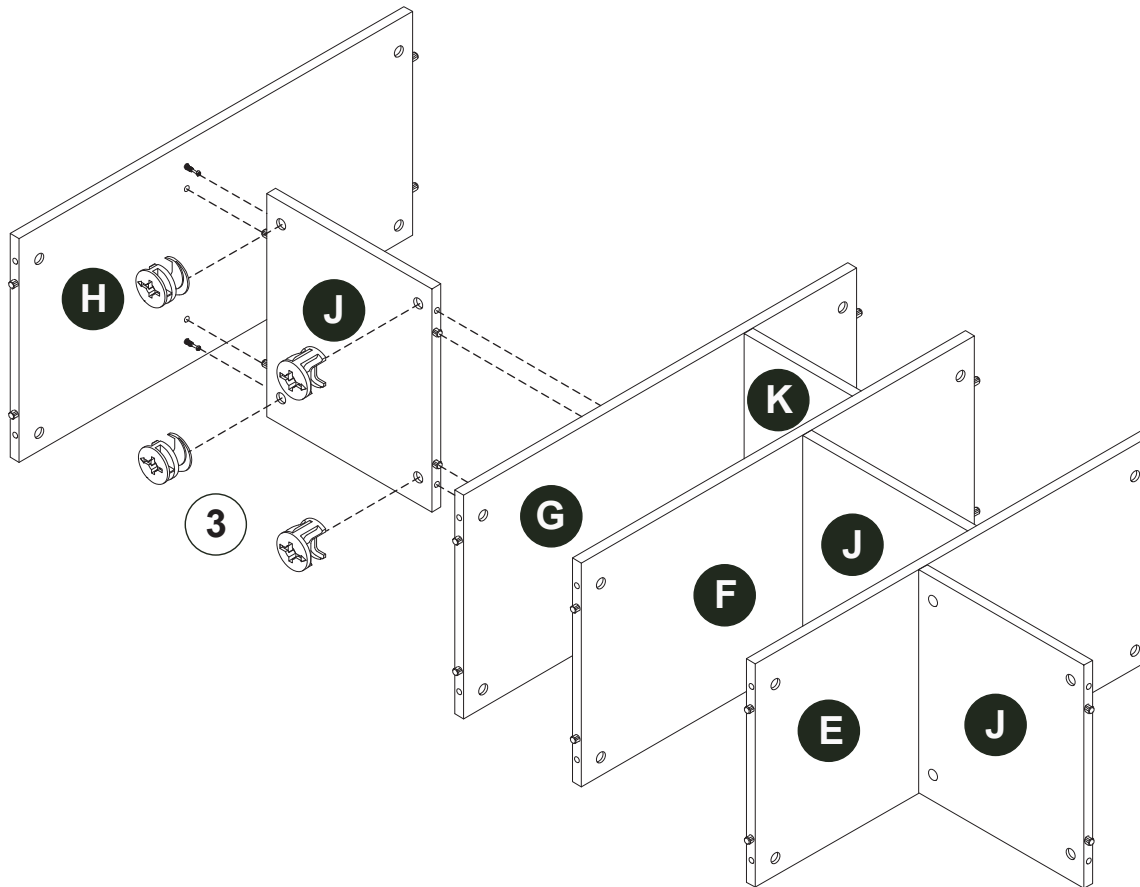

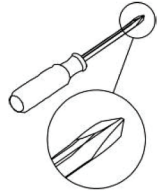

Phillips head screwdriver

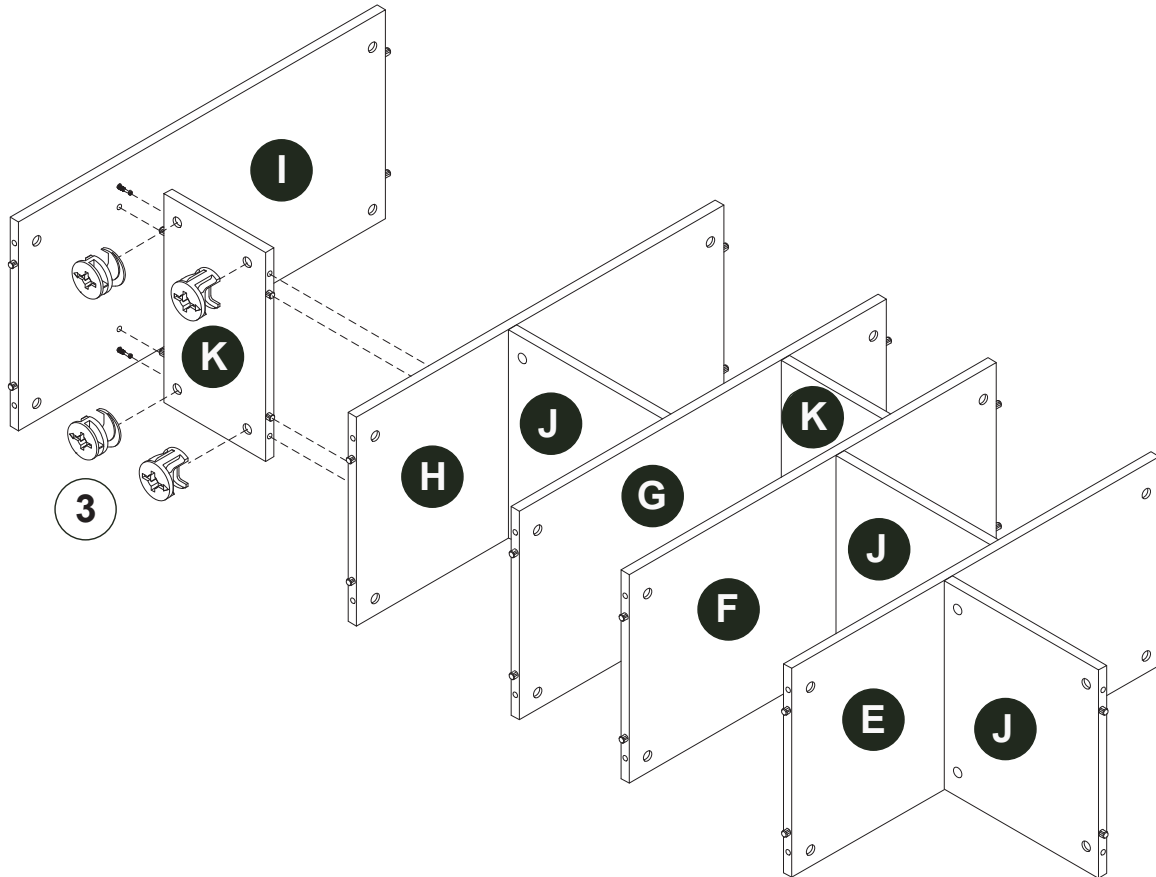
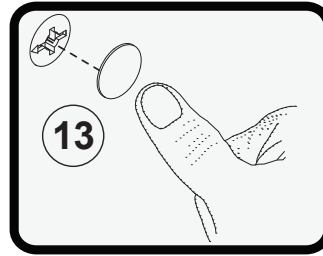
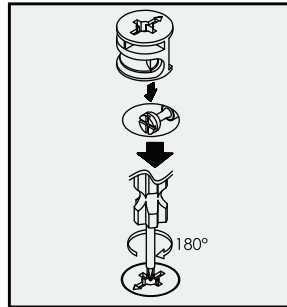

Step 8

Insert cam (3) to panel (K) as shown, then attach panel (K) to panel (H) and (I), tighten all the cam (3) with screwdriver.

Insert screw cap (13) on cam (3) as shown.

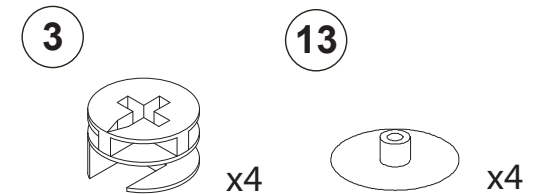

Step 9

Insert cam (3) to panel (J) as shown, then attach panel (J) to panel (I), tighten all the cam (3) with screwdriver.

Insert screw cap (13) on cam (3) as shown.



Phillips head screwdriver

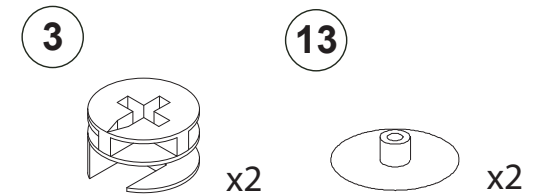
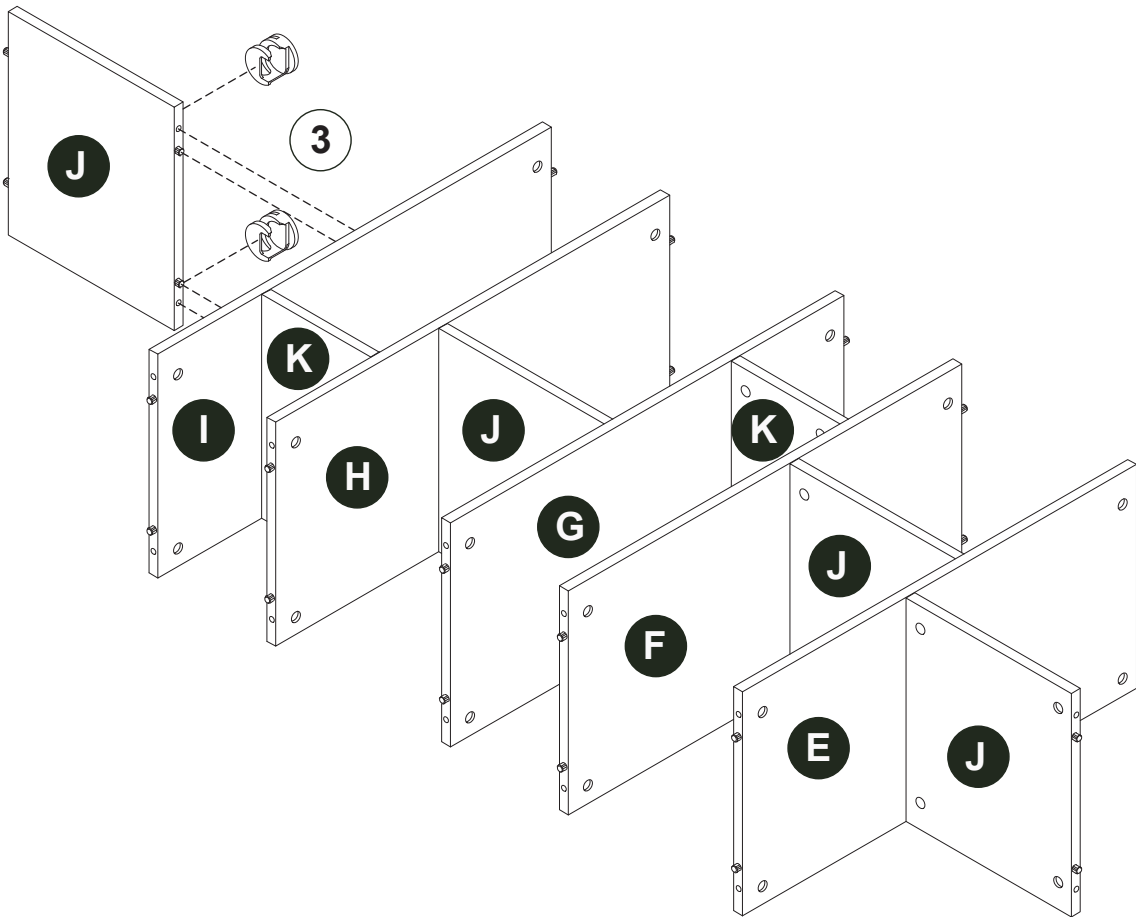
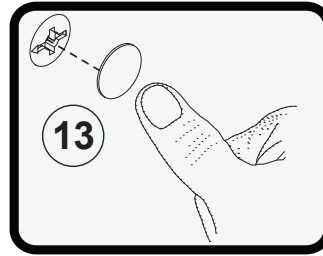
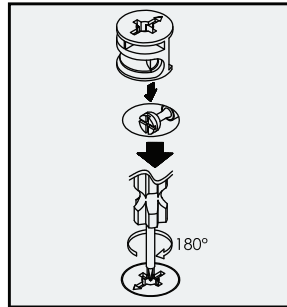

Step 10



Phillips head screwdriver

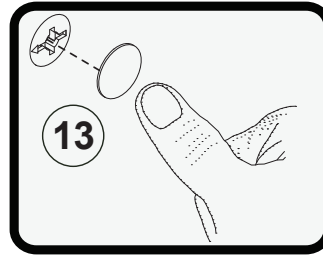
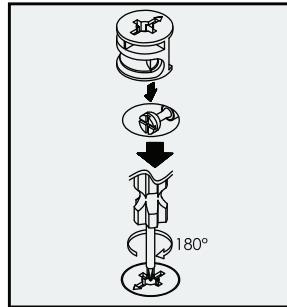

Insert cam (3) to panel (E) , (F) , (G) , (H) and (I) as shown, then attach to panel (A) and (B), tighten all the cam (3) with screwdriver.

Insert screw cap (13) on cam (3) as shown.

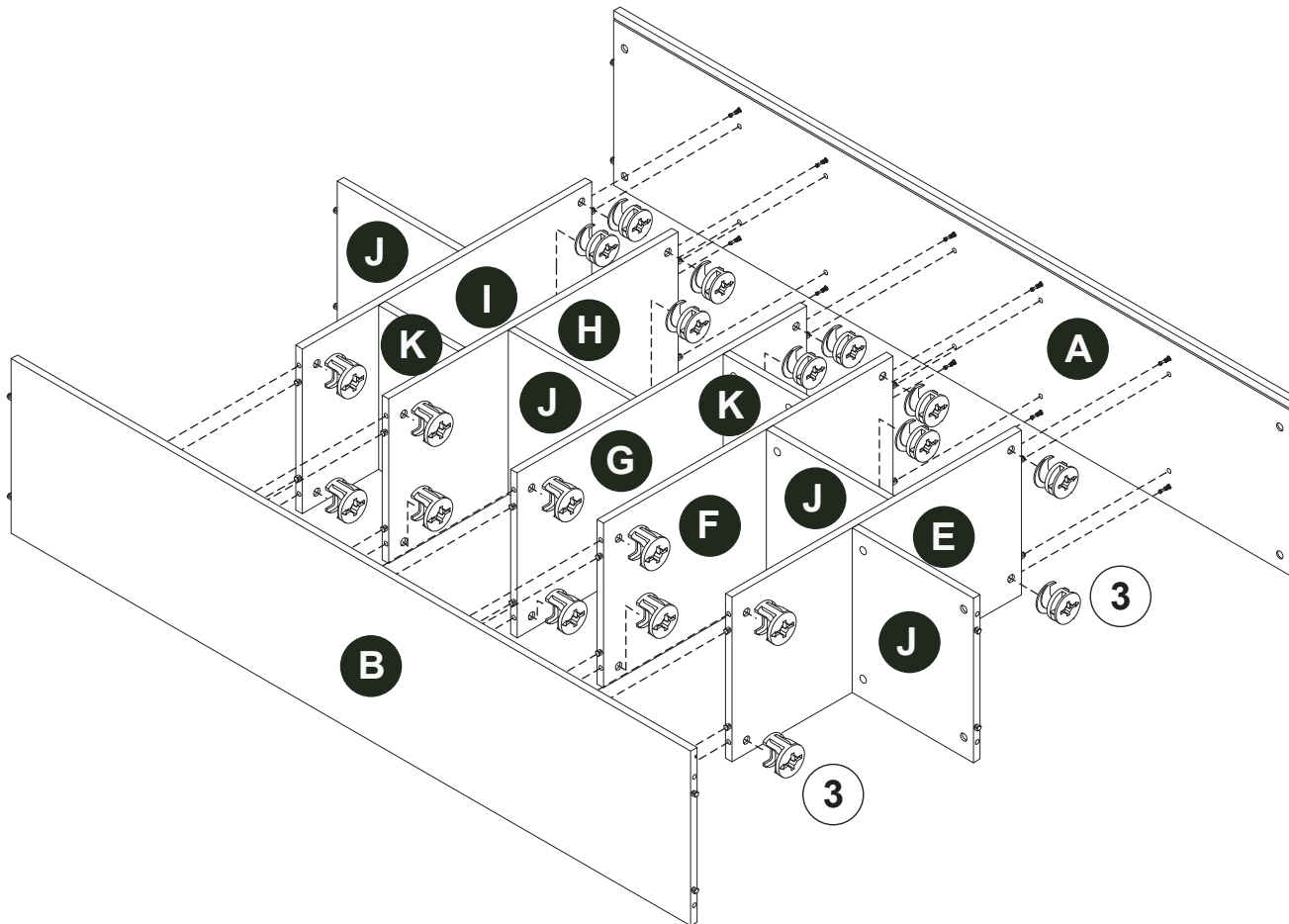

3

13

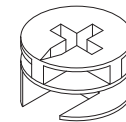

x20



x20

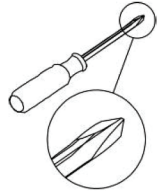

Phillips head screwdriver

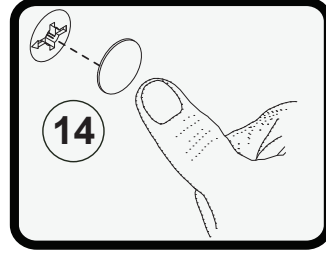
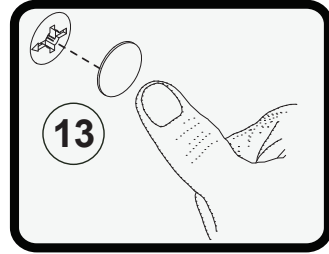
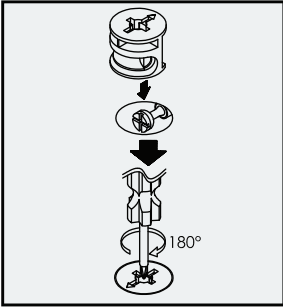

Step 11

Insert cam (3) to panel (A) , (B) and (J) as shown, then attach to panel (C) to panel (A), (B) and (J), tighten all the cam (3) with screwdriver.

Insert screw cap (13) on cam (3) of panel (J) as shown.

Insert screw cap (14) on cam (3) of panel (A) and (B) as shown.

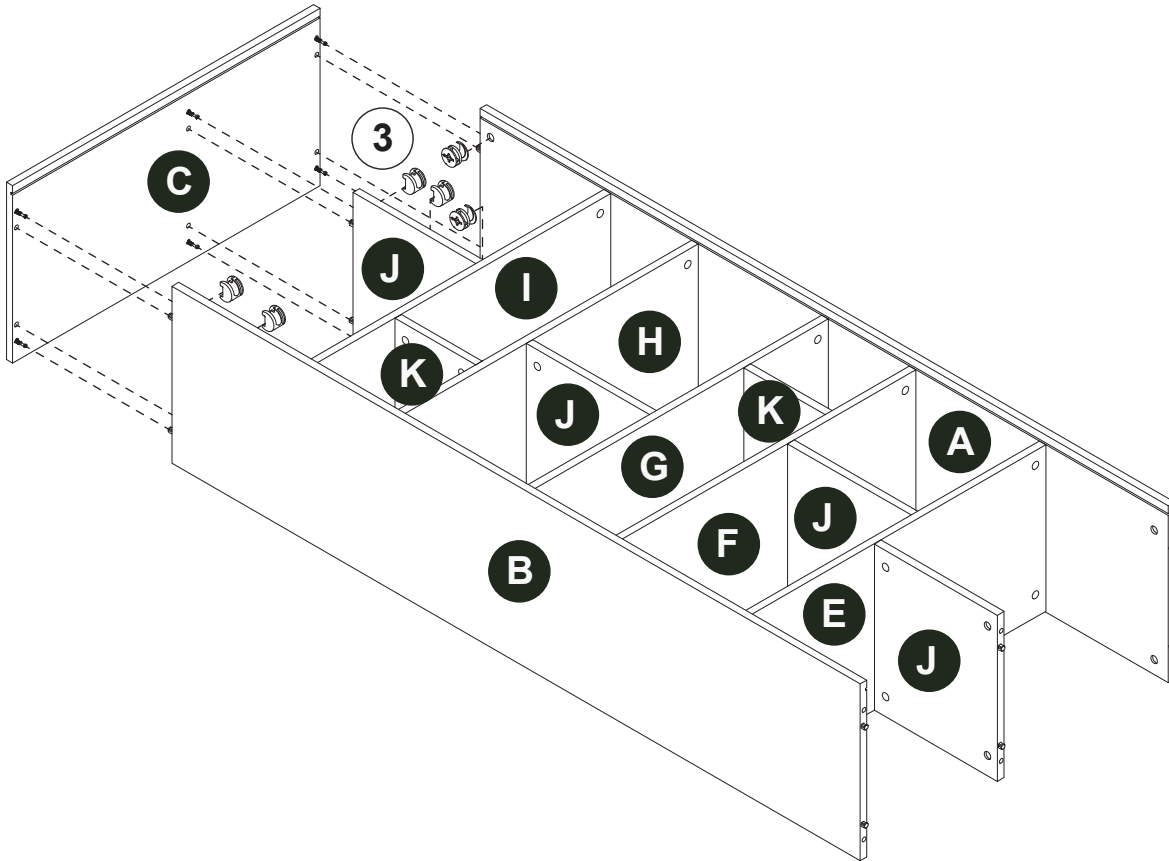

3

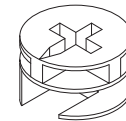

x6

13

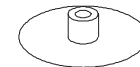

x2

14

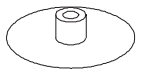

x4

Step 12

Insert the panel (L) into groove of panel (A) and (B) as shown.

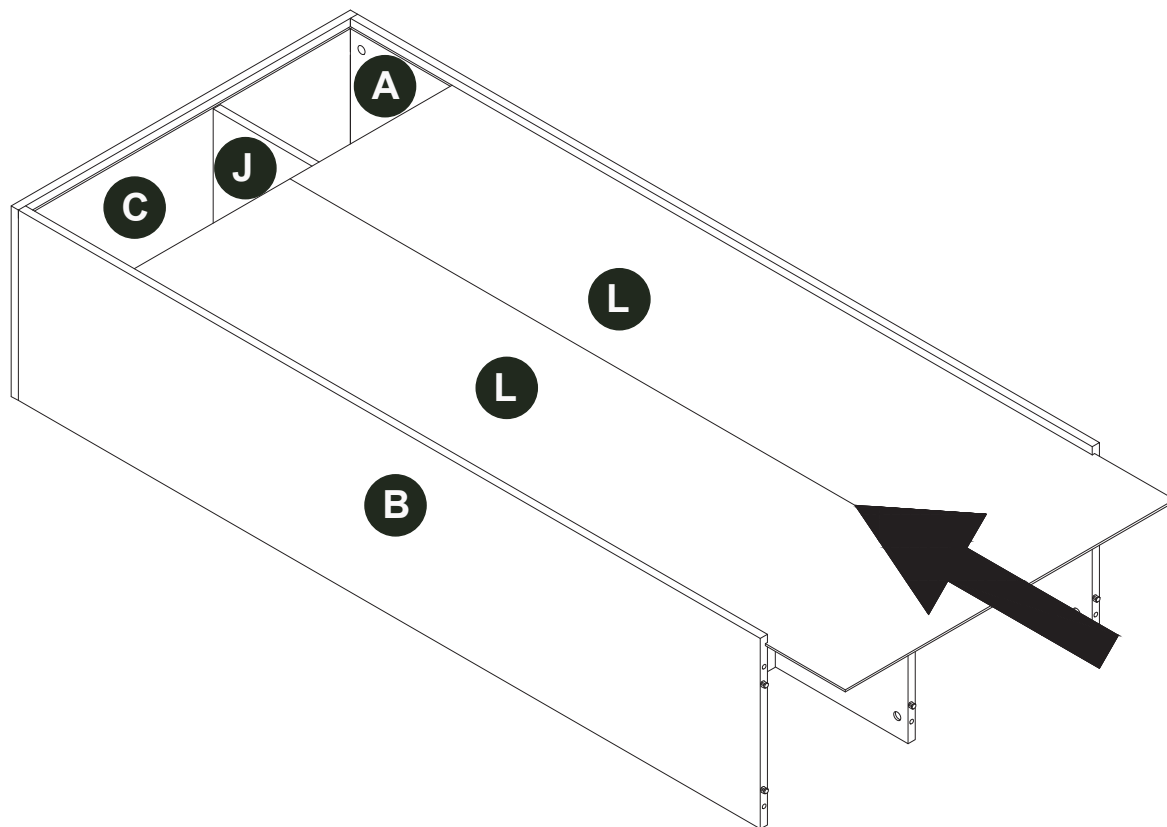
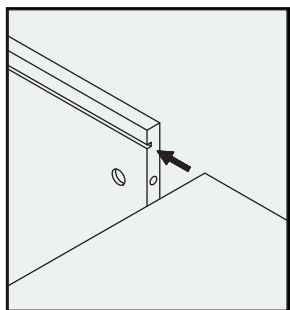

Step 13

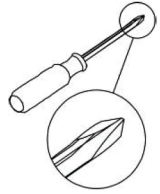
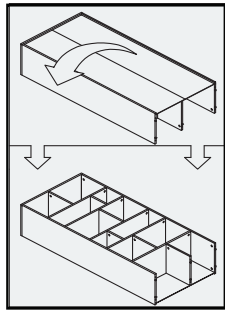

Phillips head screwdriver

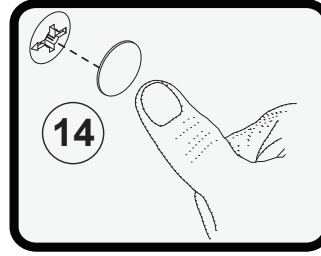
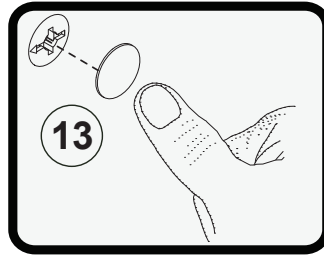
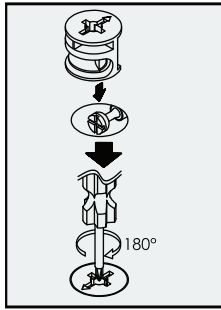

Before start Step 13 , turn the furniture as shown.

Insert cam(3) to panel **(A)** , **(B)** and **(J)** as shown, then attach to panel **(D)** to panel **(A)** , **(B)** and **(J)** , tighten all the cam (3) with screwdriver.

Insert screw cap (13) on cam (3) of panel **(J)** as shown.

Insert screw cap (14) on cam (3) of panel **(A)** and **(B)** as shown.

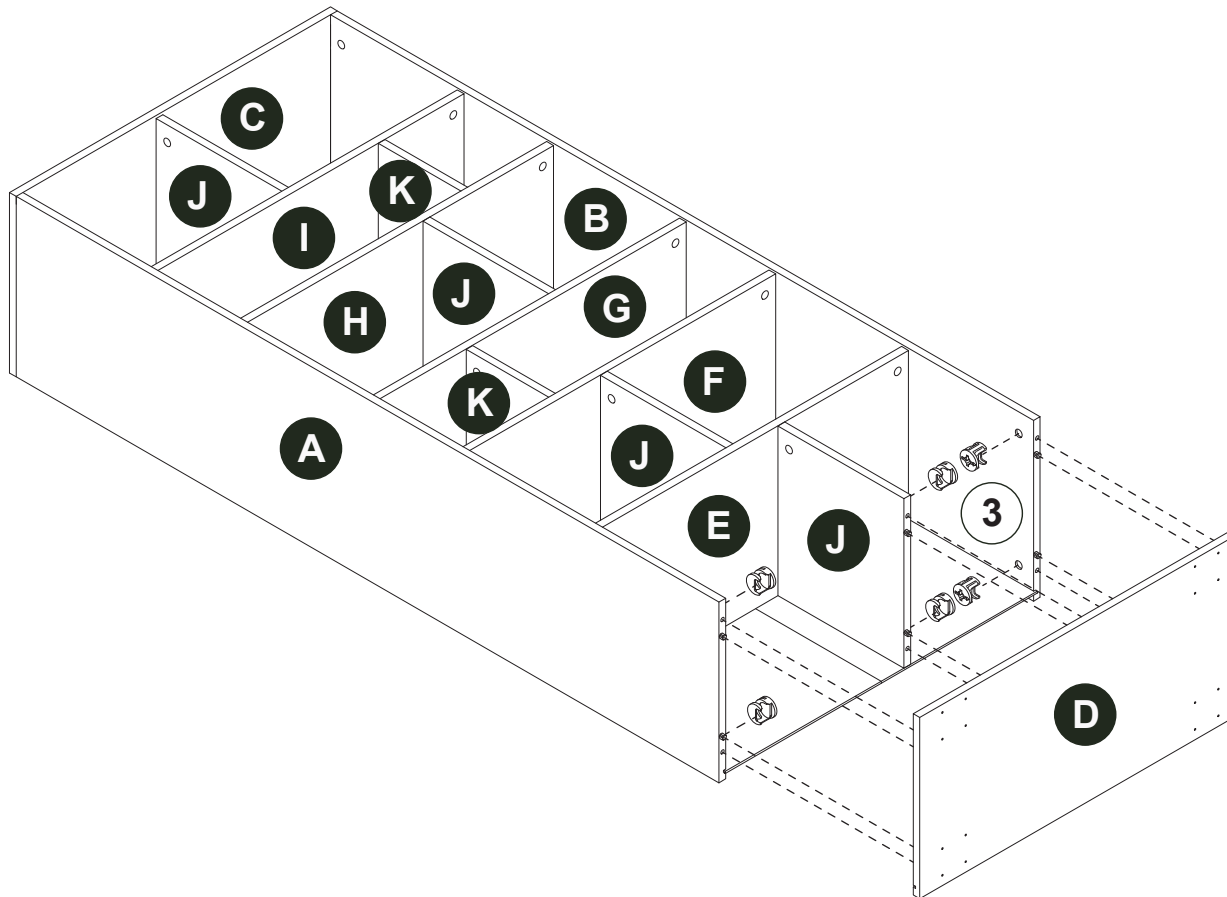

3

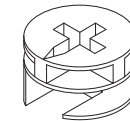

x6

13

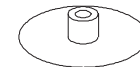

x2

14

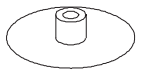

x4

Step 14

Attach the round leg (12) to panel (D), use screw (11) to secure as shown.



Phillips head screwdriver

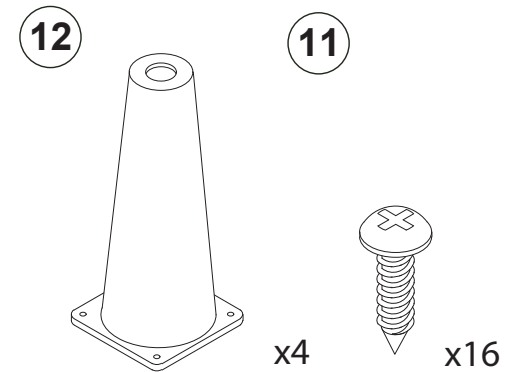
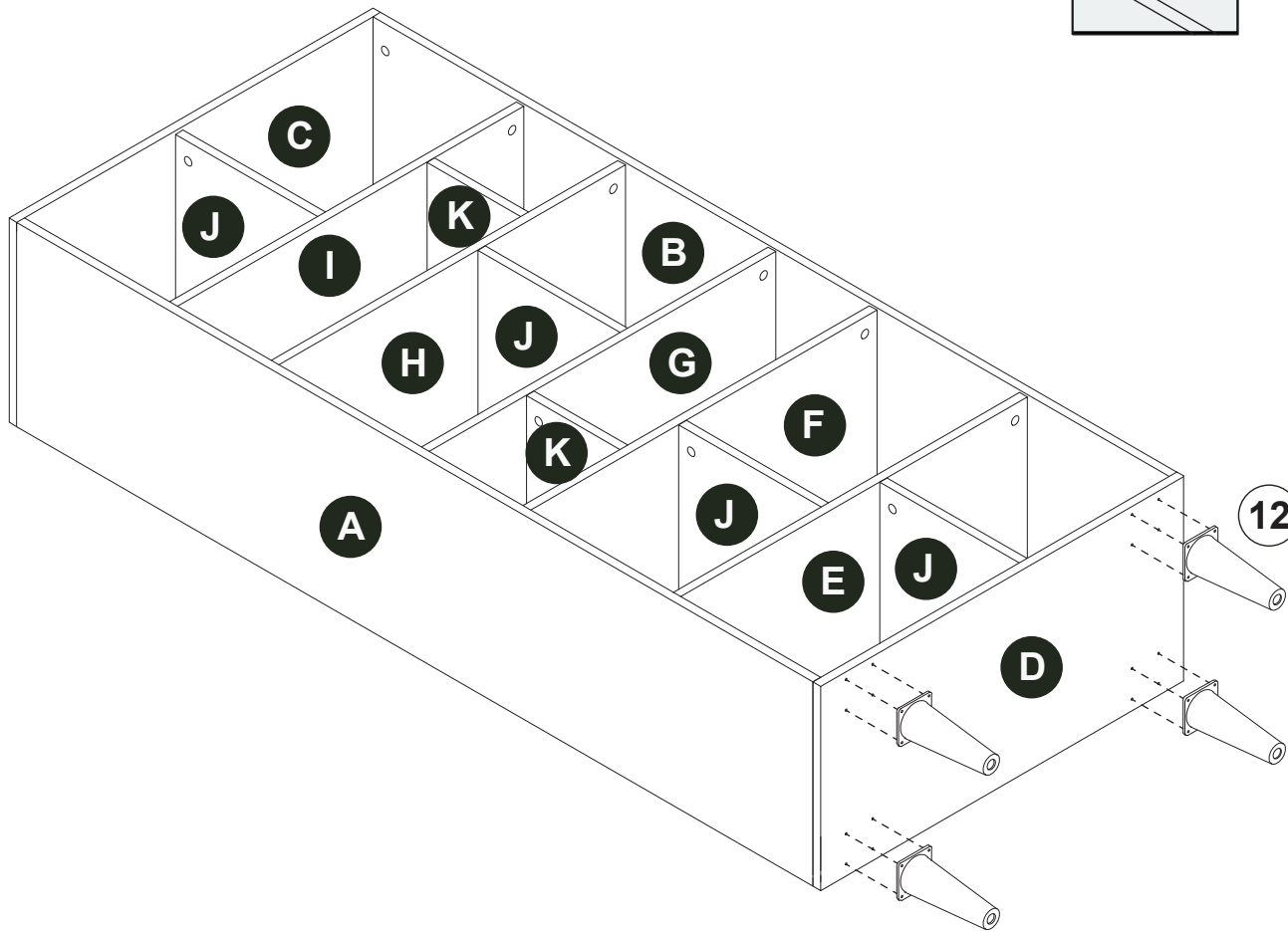
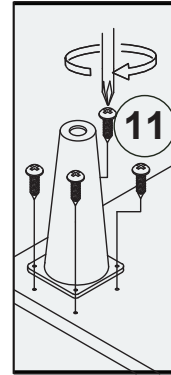

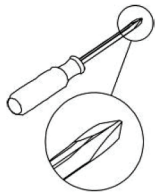

Phillips head screwdriver

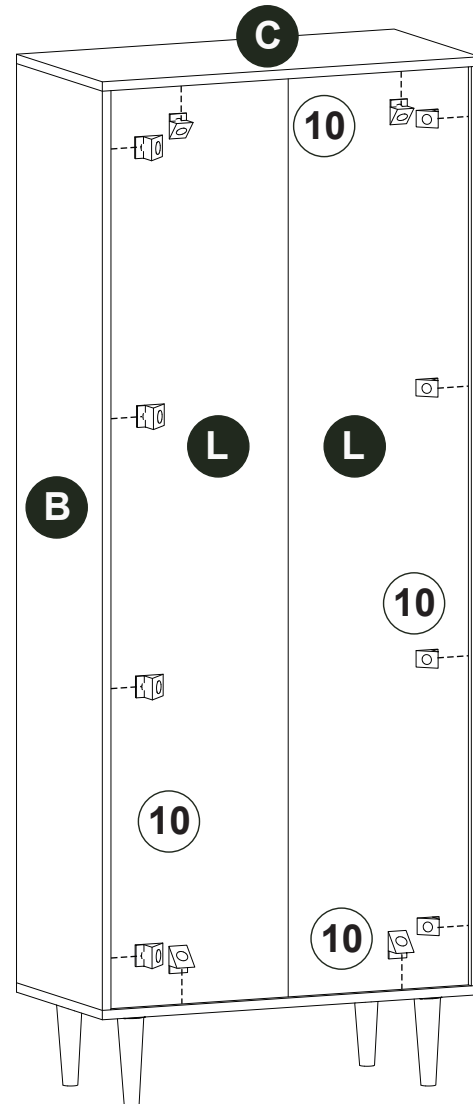
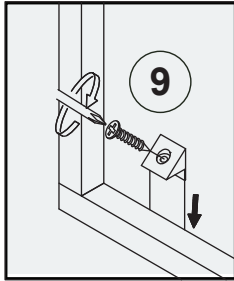

Step 15

Insert the corner block (10) to panel (L), use screw (9) to secure as shown.

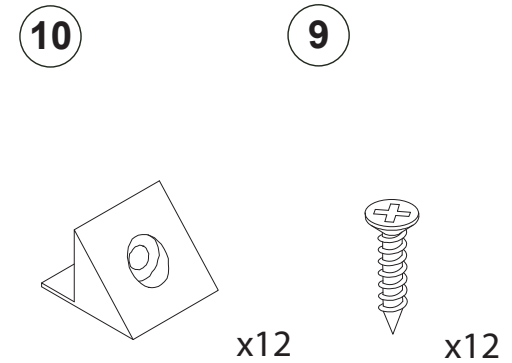

Step 16

Insert the wall bracket (7a) to panel (C) with screw (7b) as shown, do not tighten this screw (7b) until step 17.



Phillips head screwdriver

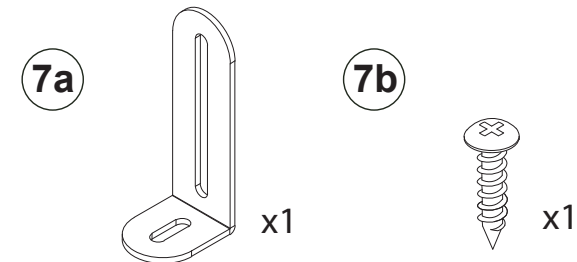
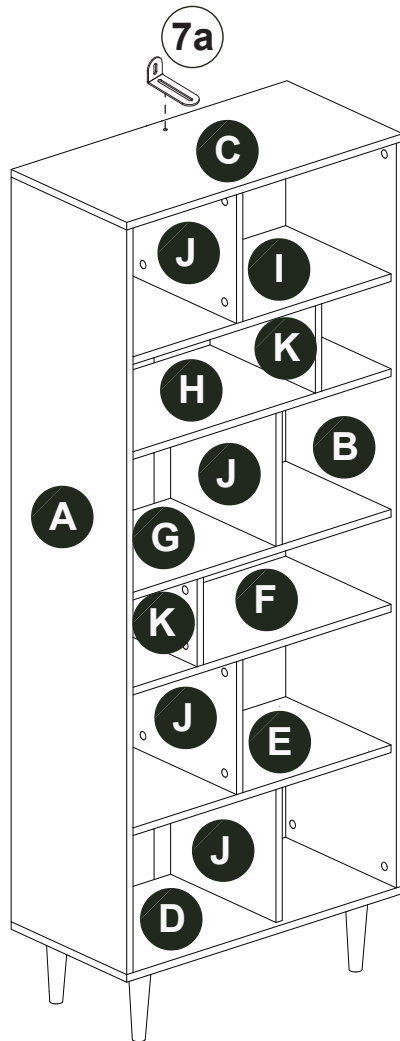
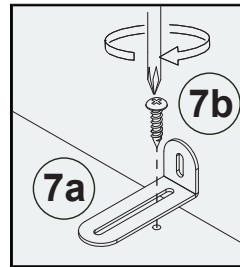

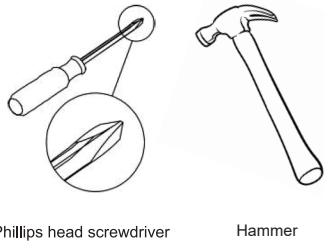
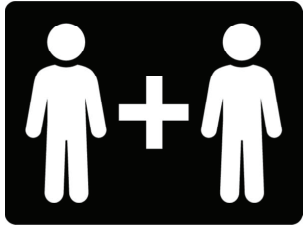

Phillips head screwdriver

Hammer

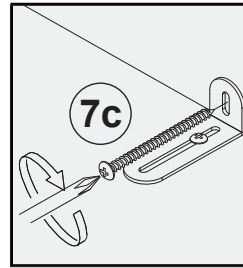

7c

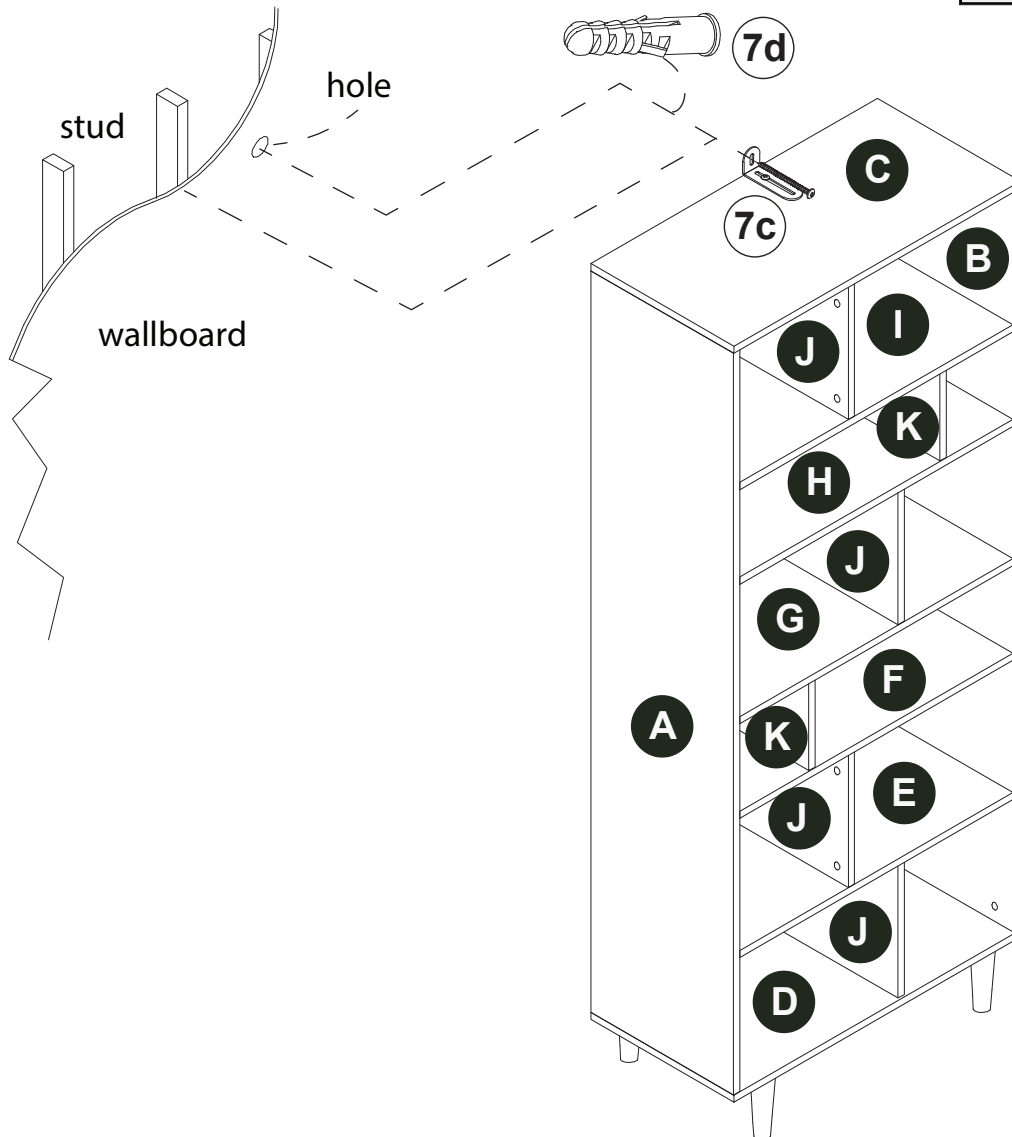

Step 17

Option 1;
Securely screw (7c) into solid area of the wall, as a stud.

Option 2 ;
Drill a 3/16" diameter hole (5mm) in the wallboard. Tap the wall anchor(7d) into the hole, with a hammer, until it is flush. Fasten the wall bracket(7a) to the wall anchor(7d) with screw(7c).

Now tighten the screw(7b) that was left loose in step 16.

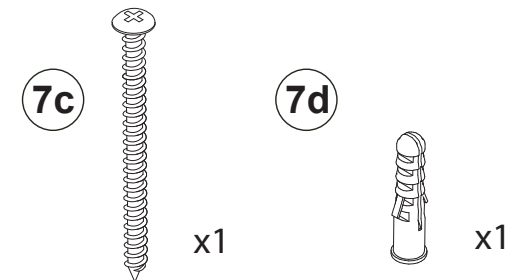

⚠ CAUTION: This unit is intended for use only with the products and/or maximum weights indicated. Use with other products and/or products heavier than the maximum weights indicated may result in instability or cause possible injury.

⚠ WARNING : Risk of injury to person
- do not place a television on this furniture is not approved for use with a television

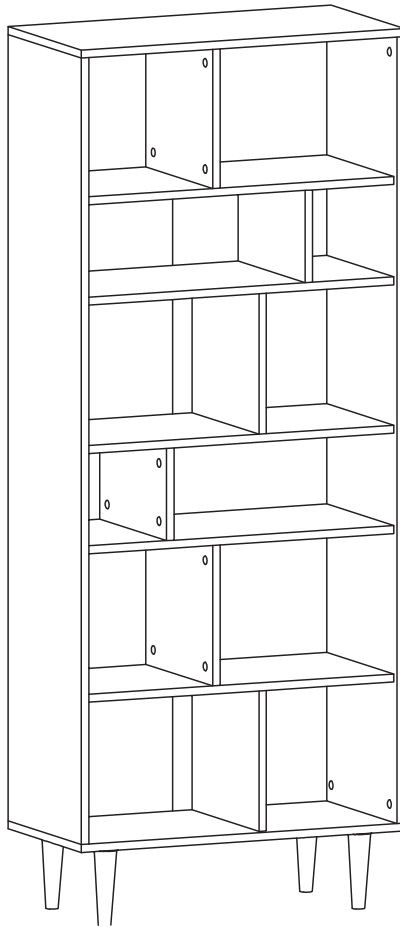

⚠ Weight Limit : 20 lbs / 9.1 KG (per shelf)

Helpful Hints

- Move your new furniture carefully, with two people lifting and carrying the unit to its new location.
- Your furniture can be disassembled and reassembled to move.
- Clean the product with a soft damp cloth. DO NOT use harsh chemicals or abrasive cleaners.
- Check bolts and nuts periodically and tighten if necessary.

That's it ! You've finished assembling your **RH REKAL BOOKCASE!**

Partes

IMPORTANTE: La lista de números de piezas que aparece a continuación es exclusiva de su producto. Por favor, manténgalo a mano cuando solicite piezas de repuesto.

 Todo se incluye en **1/1** caja(s) grande(s)!

 Antes de deshacerse de las cajas de cartón, asegúrese de que estén vacías. También confirme que ha recibido todos los componentes necesarios para el ensamblaje al compararlos con la tabla de piezas indicadas en la sección en inglés.

Paquete de componentes

3031109RR (Robel/Blanco)

■ □ HP # : TU1770852-01

 **Nota:** Por favor apriete completamente los pernos durante el ensamblaje, apriételes en la última etapa del ensamblaje, a menos que este indicado específicamente en alguna etapa de las instrucciones.

 Los tornillo(s), perno(s) que se utilizan en cada paso se muestran en tamaño real en la esquina inferior derecha de cada página.

NÚMERO DE PIEZAS		
ETIQUETAS	DESCRIPCIÓN	3031109RR (Robel/Blanco)
A	Panel Lateral Izquierdo	U1770852-A
B	Panel Lateral Derecho	U1770852-B
C	Panel Superior	U1770852-C
D	Panel Inferior	U1770852-D
E	Panel De Estante 1	U1770852-E
F	Panel De Estante 2	U1770852-F
G	Panel De Estante 3	U1770852-G
H	Panel De Estante 4	U1770852-H
I	Panel De Estante 5	U1770852-I
J	Panel Central 1	U1770852-J
K	Panel Central 2	U1770852-K
L	Panel Posterior	U1770852-L

Instrucciones

Paso 1 Inserte la clavija (8) en el panel de los paneles como se muestra.

Paso 2 Insertar el minifix (2) y luego apretarlo con un destornillador.

Paso 3 Insertar el minifix (2) y luego apretarlo con un destornillador.

Paso 4 Inserte la leva (3) al panel (J) como se muestra, luego fije el panel (J) al panel (E), apriete todas las levas (3) con un destornillador.
Inserte el tapón de rosca (13) en la leva (3) como se muestra.

Paso 5 Inserte la leva (3) al panel (J) como se muestra, luego fije el panel (J) al panel (E) y (F), apriete todas las levas (3) con un destornillador.
Inserte el tapón de rosca (13) en la leva (3) como se muestra.

Paso 6 Inserte la leva (3) al panel (K) como se muestra, luego fije el panel (K) al panel (F) y (G), apriete todas las levas (3) con un destornillador.
Inserte el tapón de rosca (13) en la leva (3) como se muestra.

Paso 7 Inserte la leva (3) al panel (J) como se muestra, luego fije el panel (J) al panel (G) y (H), apriete todas las levas (3) con un destornillador.
Inserte el tapón de rosca (13) en la leva (3) como se muestra.

Paso 8 Inserte la leva (3) al panel (K) como se muestra, luego fije el panel (K) al panel (H) y (I), apriete todas las levas (3) con un destornillador.
Inserte el tapón de rosca (13) en la leva (3) como se muestra.

Paso 9 Inserte la leva (3) al panel (J) como se muestra, luego fije el panel (J) al panel (I), apriete todas las levas (3) con un destornillador.
Inserte el tapón de rosca (13) en la leva (3) como se muestra.

Paso 10 Inserte la leva (3) al panel (E), (F), (G), (H) y (I) como se muestra, luego fije el panel al panel (A) y (B), apriete todas las levas (3) con destornillador.
Inserte el tapón de rosca (13) en la leva (3) como se muestra.

Paso 11 Inserte la leva (3) al panel (A), (B) y (J) como se muestra, luego fíjela al panel (C) al panel (A), (B) y (J), apriete todas las levas (3) con destornillador.
Inserte el tapón de rosca (13) en la leva (3) del panel (J) como se muestra.
Inserte el tapón de rosca (14) en la leva (3) del panel (A) y (B) como se muestra.

Paso 12 Inserte el panel (L) en la ranura del panel (A) y (B) como se muestra.

Paso 13 Antes de comenzar el Paso 13, gire los muebles como mostrado.
Inserte la leva (3) al panel (A), (B) y (J) como se muestra, luego fíjela al panel (D) al panel (A), (B) y (J), apriete todas las levas (3) con destornillador.
Inserte el tapón de rosca (13) en la leva (3) del panel (J) como se muestra.
Inserte el tapón de rosca (14) en la leva (3) del panel (A) y (B) como se muestra.

Paso 14 Conecte la pata redonda (12) al panel (D), use el tornillo (11) para asegurar como se muestra.

Paso 15 Inserte el bloque de esquina (10) en el panel (L), use el tornillo (9) para asegurarlo como se muestra.

Paso 16 Fije el soporte de pared (7a) al panel (C) con el tornillo (7b) como se muestra, no apriete este tornillo (7b) hasta el paso 17.

Paso 17 Opción 1;
Atornille firmemente (7c) en un área sólida de la pared, como un montante.

Opción 2 ;
Taladre un orificio de 3/16" de diámetro (5 mm) en el panel de yeso. Introduzca el anclaje de pared (7d) al agujero, con un martillo, hasta que quede al ras. Fije el soporte de pared (7a) a la pared. anclaje (7d) con tornillo (7c).

Ahora apriete el tornillo (7b) que quedó suelto en el paso 16.

Consejos utiles

- Mueva sus muebles nuevos con cuidado, se requiere de dos personas para levantar y trasladar su producto a su nueva ubicación.
- Sus muebles se pueden desmontar y volver a ensamblar en caso de mudanza.
- Limpie el producto con un paño suave. NO utilice productos químicos o abrasivos de limpieza.
- Revise los tornillos y tuercas periódicamente y apriételes si es necesario.

PRECAUCIÓN

- Esta unidad está diseñada para ser utilizada únicamente con los productos y/o pesos máximos indicados. Su uso con otros productos y/o productos más pesados que los pesos máximos indicados puede provocar inestabilidad o causar lesiones.

ADVERTENCIA:

Riesgo de lesiones personales

- No colocar un televisor sobre este mueble no está aprobado.
para usar con un televisor

 Límite de peso : 20 lbs / 9.1 KG (por estante)

3031109RR(Chêne/Blanc)

BIBLIOTHÈQUE RH RAKEL

Date d'achat

Numéro de lot

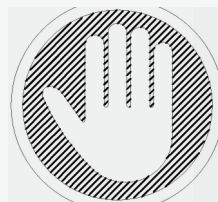

Des questions, des préoccupations ou des pièces manquantes? **CONTACTEZ NOTRE SERVICE À LA CLIENTÈLE AVANT DE RETOURNER LE PRODUIT AU DÉTAILLANT.**

Si des pièces sont manquantes ou endommagées, nous expédierons volontiers vos pièces de rechange gratuitement.

Visitez www.realrooms.com, appelez sans frais au **1-888-489-0077**



CE FEUILLET CONTIENT DES INFORMATIONS DE SÉCURITÉ **IMPORTANTES**. S'IL VOUS PLAÎT LIRE ET CONSERVER POUR RÉFÉRENCE ULTERIEURE.

Merci d'avoir acheté un produit Realrooms!

Informations sur la garantie

RealRooms garantit que ce produit est exempt de tout vice de matériaux et de fabrication et s'engage à remédier à un tel défaut. Cette garantie est valable un an à compter de la date d'achat initiale. Elle se limite uniquement à la réparation ou au remplacement des pièces défectueuses. La main-d'oeuvre nécessaire à l'assemblage n'est pas incluse.

Cette garantie ne s'applique pas aux produits qui ont été mal assemblés, qui ont été soumis à une utilisation abusive ou qui ont subi des modifications ou des réparations. La garantie ne couvre pas l'usure, les déchirures ou la décoloration du tissu (le cas échéant). La responsabilité pour les dommages indirects est exclue quand l'exclusion est autorisée par la loi. Cette garantie vous confère des droits spécifiques légaux. Il se peut que vous bénéficiiez de droits additionnels car ceux-ci peuvent varier selon l'État ou la province.

Pour bénéficier du service de garantie, l'acheteur doit présenter la facture originale. Les composants réparés ou remplacés sont garantis jusqu'à la fin de la période de la garantie initiale uniquement. Les composants défectueux seront réparés ou remplacés sans frais, sous réserve des conditions décrites ci-dessus. Les termes et conditions de la garantie limitée sont susceptibles d'être modifiés sans préavis.

Précautions

- Ce produit est conçu pour un usage domestique et n'est pas destiné à des fins commerciales.
- **AVERTISSEMENT CONCERNANT LES JEUNES ENFANTS:** Ce produit contient des petits composants. S'il vous plaît assurez-vous qu'ils soient gardés loin d'eux.
- Ne pas utiliser d'outils électriques pour assembler votre mobilier. Ce type d'outils risque d'endommager les pièces.

Avant de commencer l'assemblage

- Si vous avez besoin d'aide, appelez notre service à la clientèle sans frais.
- Travaillez dans un endroit spacieux et près du lieu où l'unité sera utilisée, préférablement sur un tapis, ou sur un morceau de l'emballage, afin de protéger le plancher et le produit.
- **Nombre de personnes recommandées pour l'assemblage : 1** (cependant il est toujours préférable d'être assisté par une personne supplémentaire).
- **Temps estimé d'assemblage : 1:30 h.**
- Assurez-vous d'avoir bien reçu toutes les pièces. La plupart de celles-ci sont étiquetées ou estampées sur leur côté non fini.
- Lire attentivement chaque étape avant de débiter. Il est très important que chaque étape de montage soit exécutée dans le bon ordre, sinon vous risquez d'éprouver de la difficulté à assembler votre meuble.

Contactez-nous!

Besoin d'aide pour assembler, identifier des pièces, vous informer sur le produit, ou pour commander des pièces? Contactez-nous :

- cs@realrooms.com
- 1-888-489-0077

Pièces

IMPORTANT: La liste des références ci-dessous est propre à votre produit.
Veuillez l'avoir sous la main lorsque vous appelez pour des pièces de rechange.

 Tout dans **1/1** grande(s) boîte(s)!

 Avant de jeter les boîtes en carton, assurez-vous qu'elles soient vides.
Vérifiez que vous avez reçu tous les composants nécessaires à l'assemblage en les comparant avec le tableau des pièces (illustrations disponibles dans la section en anglais).

Quincaillerie

3031109RR (Chêne/Blanc)	<input type="checkbox"/> HP # : TU1770852-01
-------------------------	--

 **Remarque:** Sauf indication contraire dans les instructions, ne pas resserrer complètement les vis et les boulons, jusqu'à ce que l'assemblage soit terminé.

 Les vis et boulons utilisés durant chaque étape sont illustrés en taille réelle au coin inférieur droit de la page.

LISTE DES PIÈCES

ÉTIQUETTE DES PIÈCES	DESCRIPTION	3031109RR (Chêne/Blanc)
A	Panneau Latéral Gauche	U1770852-A
B	Panneau Latéral Droit	U1770852-B
C	Panneau Du Haut	U1770852-C
D	Panneau Du Bas	U1770852-D
E	Panneau D'étagère 1	U1770852-E
F	Panneau D'étagère 2	U1770852-F
G	Panneau D'étagère 3	U1770852-G
H	Panneau D'étagère 4	U1770852-H
I	Panneau D'étagère 5	U1770852-I
J	Panneau Central 1	U1770852-J
K	Panneau Central 2	U1770852-K
L	Panneau Dos	U1770852-L

Instructions

Étape 1 Insérez la cheville (8) sur les panneaux comme indiqué.

Étape 2 Insérez le minifix (2) sur les panneaux comme indiqué, serrez avec un tournevis.

Étape 3 Insérez le minifix (2) sur les panneaux comme indiqué, serrez avec un tournevis.

Étape 4 Insérez la came (3) sur le panneau (J) comme indiqué, puis fixez le panneau (J) au panneau (E), serrez toute la came (3) avec un tournevis.
Insérez le capuchon à vis (13) sur la came (3) comme indiqué.

Étape 5 Insérez la came (3) sur le panneau (J) comme indiqué, puis fixez le panneau (J) au panneau (E) et au panneau (F), serrez toute la came (3) avec un tournevis.
Insérez le capuchon à vis (13) sur la came (3) comme indiqué.

Étape 6 Insérez la came (3) sur le panneau (K) comme indiqué, puis fixez le panneau (K) au panneau (F) et au panneau (G), serrez toute la came (3) avec un tournevis.
Insérez le capuchon à vis (13) sur la came (3) comme indiqué.

Étape 7 Insérez la came (3) sur le panneau (J) comme indiqué, puis fixez le panneau (J) au panneau (G) et au panneau (H), serrez toute la came (3) avec un tournevis.
Insérez le capuchon à vis (13) sur la came (3) comme indiqué.

Étape 8 Insérez la came (3) sur le panneau (K) comme indiqué, puis fixez le panneau (K) au panneau (H) et au panneau (I), serrez toute la came (3) avec un tournevis.
Insérez le capuchon à vis (13) sur la came (3) comme indiqué.

Étape 9 Insérez la came (3) sur le panneau (J) comme indiqué, puis fixez le panneau (J) au panneau (I), serrez toute la came (3) avec un tournevis.
Insérez le capuchon à vis (13) sur la came (3) comme indiqué.

Étape 10 Insérez la came (3) sur le panneau (E), (F), (G), (H), (I) comme indiqué, puis fixez-la au panneau (A) et au panneau (B), serrez toute la came (3) avec Tournevis.
Insérez le capuchon à vis (13) sur la came (3) comme indiqué.

Étape 11 Insérez la came (3) sur les panneaux (A), (B) et (J) comme indiqué, puis fixez-la au panneau (C) sur les panneaux (A), (B) et (J), serrez toute la came (3) avec Tournevis.
Insérez le capuchon à vis (13) sur la came (3) du panneau (J) comme illustré.
Insérez le capuchon à vis (14) sur la came (3) des panneaux (A) et (B) comme illustré

Étape 12 Insérez le panneau (L) dans la rainure du panneau (A) et (B) comme indiqué.

Étape 13 Avant de commencer l'étape 13, tournez le meuble comme montré.
Insérez la came (3) sur les panneaux (A), (B) et (J) comme indiqué, puis fixez-la au panneau (D) sur les panneaux (A), (B) et (J), serrez toute la came (3) avec Tournevis.
Insérez le capuchon à vis (13) sur la came (3) du panneau (J) comme illustré.
Insérez le capuchon à vis (14) sur la came (3) des panneaux (A) et (B) comme illustré

Étape 14 Fixez le pied rond (12) au panneau (D), utilisez la vis (11) pour fixer comme indiqué.

Étape 15 Insérez le bloc d'angle (10) sur le panneau (L), utilisez la vis (9) pour fixer comme indiqué.

Étape 16 Fixez le support mural (7a) au panneau (C) avec la vis (7b) comme indiqué, ne serrez pas celui-ci (7b) avant l'étape 17.

Étape 17 Option 1;
Vissez solidement (7c) dans une zone solide du mur, comme un montant.

Option 2 ;
Percez un trou de 3/16" de diamètre (5 mm) dans le panneau mural. Appuyez sur l'ancrage mural (7d) dans le trou, avec un marteau, jusqu'à ce qu'il affleure. Fixez le support mural (7a) au mur ancre(7d) avec vis(7c).

Serrez maintenant la vis (7b) qui restait lâche à l'étape 16.

Conseils utiles

- Déplacez votre nouveau mobilier avec soin, nous recommandons deux personnes pour soulever et transporter le mobilier vers son nouvel emplacement.
- Votre mobilier peut être démonté et réassemblé pour faciliter les déménagements.
- Pour le nettoyage, utilisez un linge doux et/ou humide. N'UTILISEZ PAS de produits abrasifs ou chimiques.
- Vérifiez les vis et écrous périodiquement et resserrez-les si nécessaire.

AVERTISSEMENT

- Cette unité est destinée à être utilisée uniquement avec les produits et/ou les poids maximum indiqués. L'utilisation avec d'autres produits et/ou des produits plus lourds que les poids maximum indiqués peut entraîner une instabilité ou provoquer des blessures.

AVERTISSEMENT :

Risque de blessures corporelles
- ne pas poser de téléviseur sur ce meuble n'est pas homologué à utiliser avec un téléviseur

 Limite de poids : 20 lb / 9.1 KG (par étagère)